

リモコン三脚 Remote control Tripod Trépied à télécommande

取扱説明書

- Operating Instructions
- Mode d'emploi
- Bedienungsanleitung
- Manual de instrucciones
- Gebruiksaanwijzing
- Istruzioni per l'uso
- 使用说明书

VCT-VPR1

©2013 Sony Corporation Printed in China

A MULTI

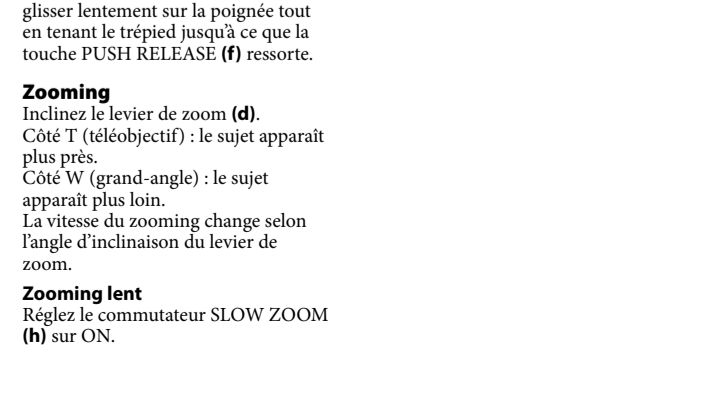
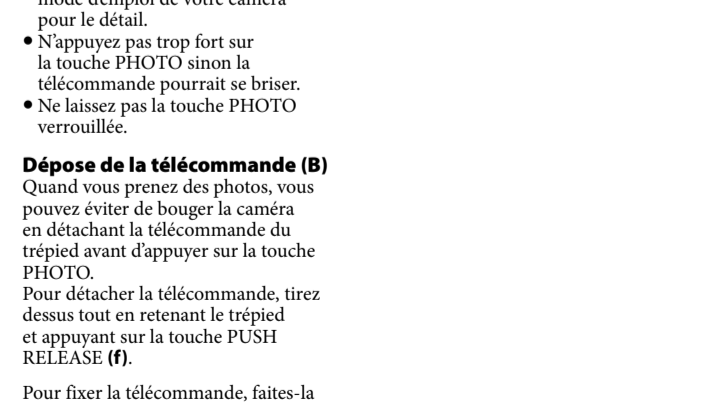
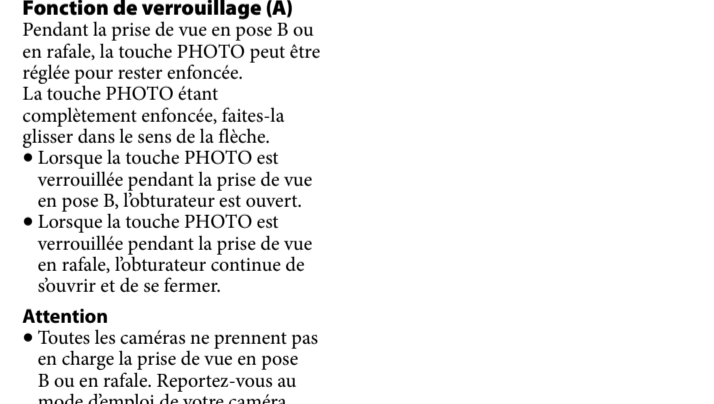
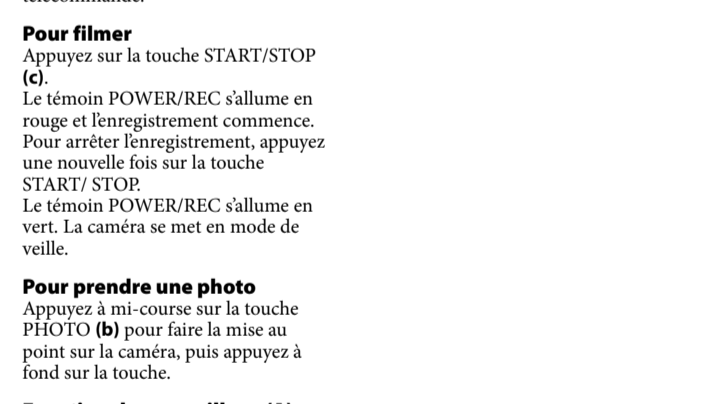
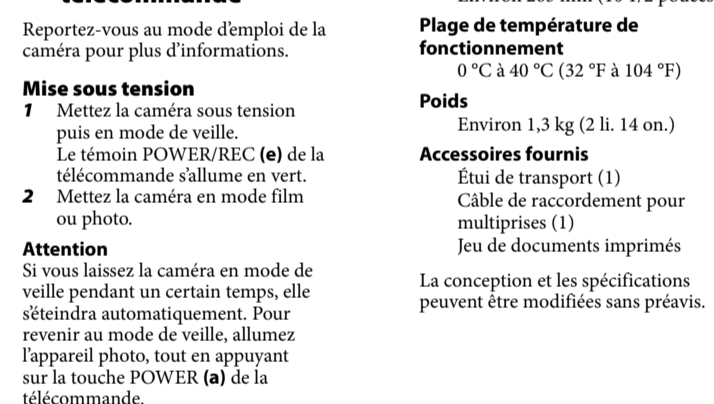
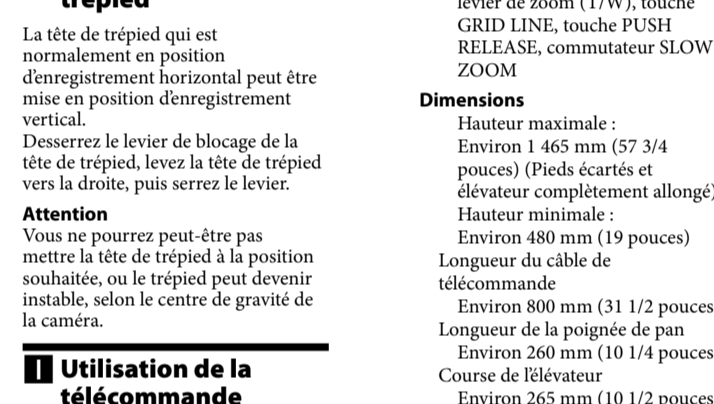
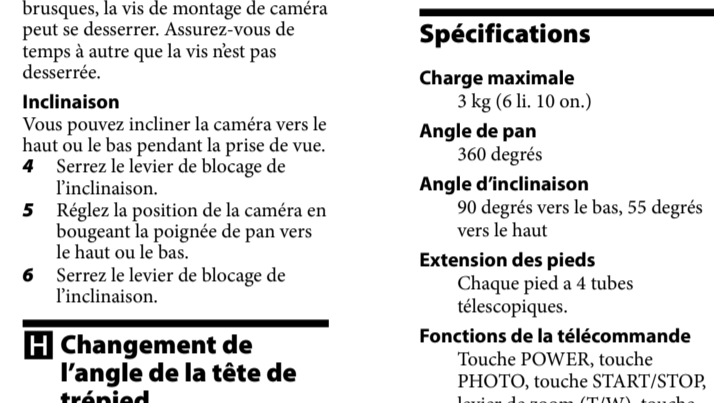
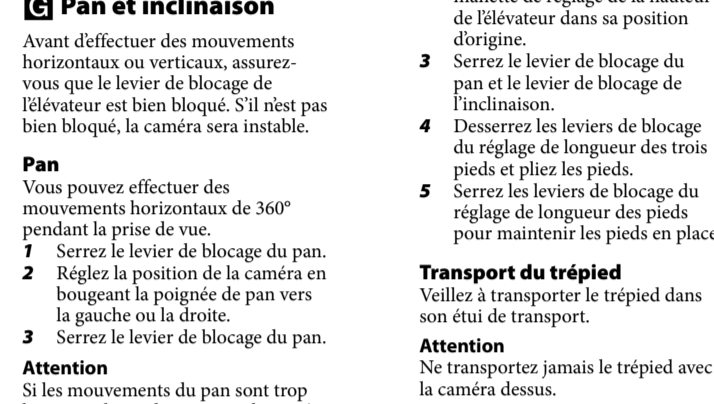
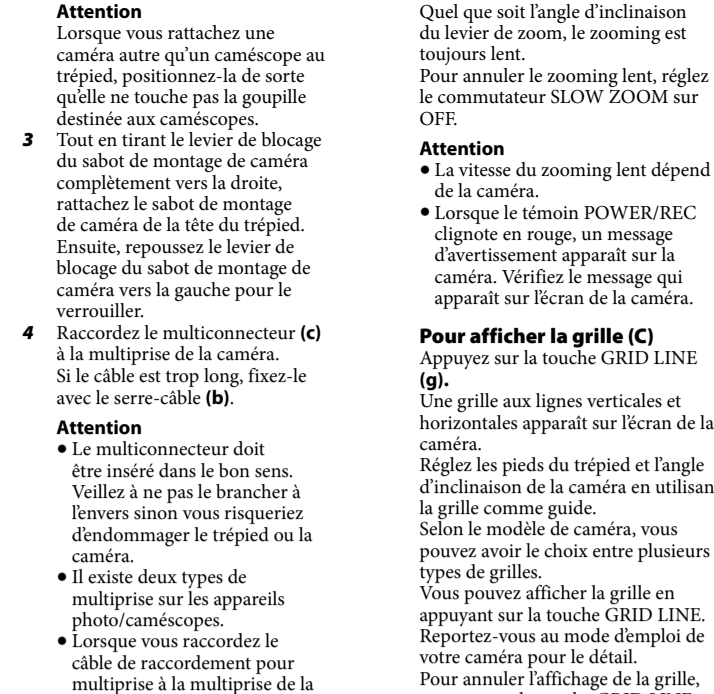
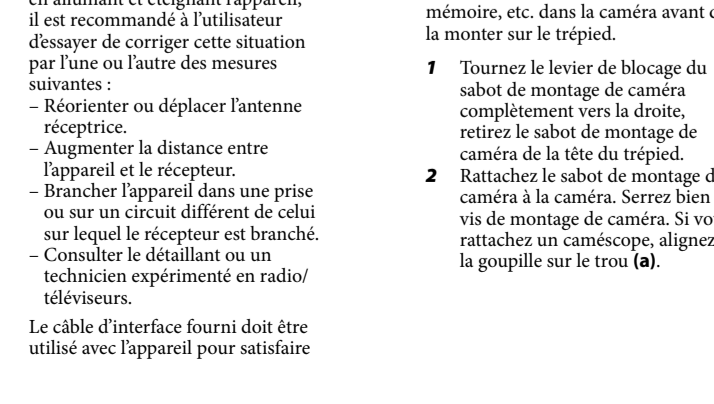
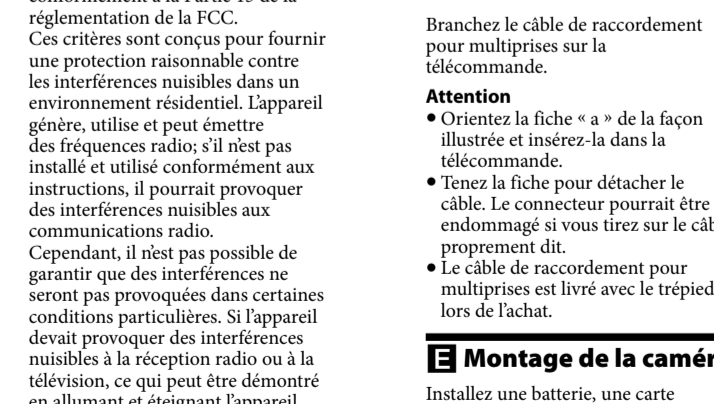
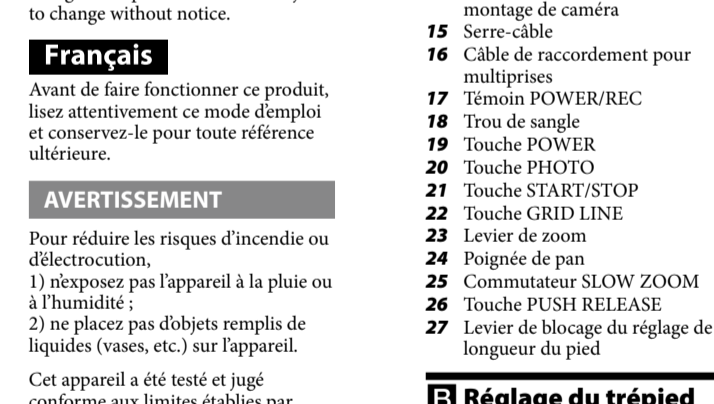
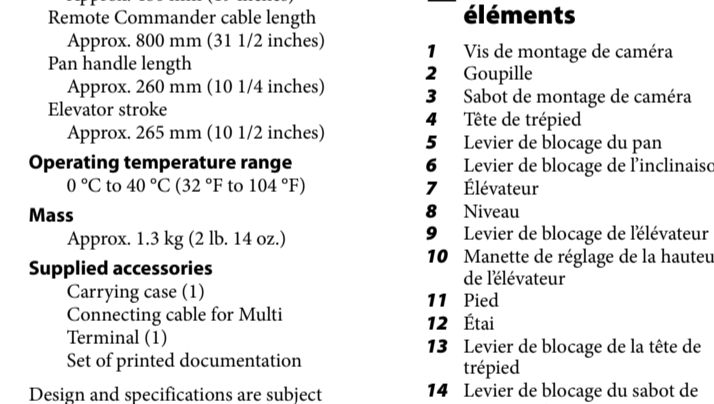
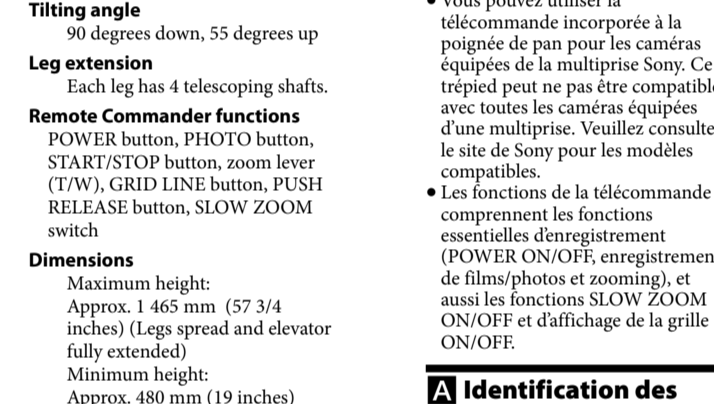
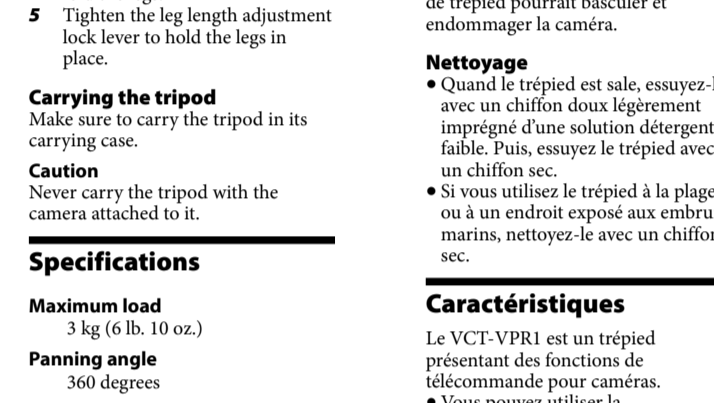
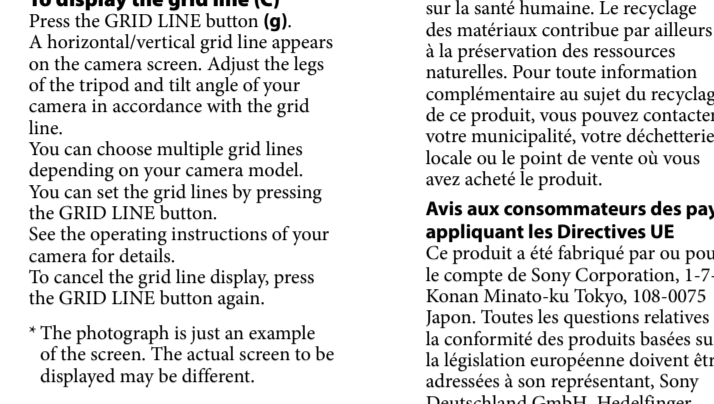
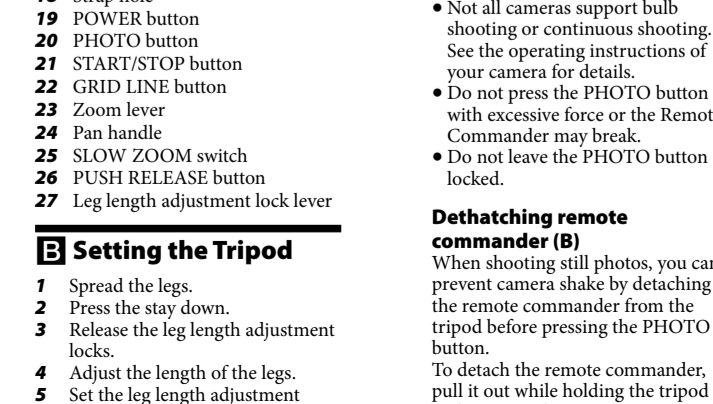
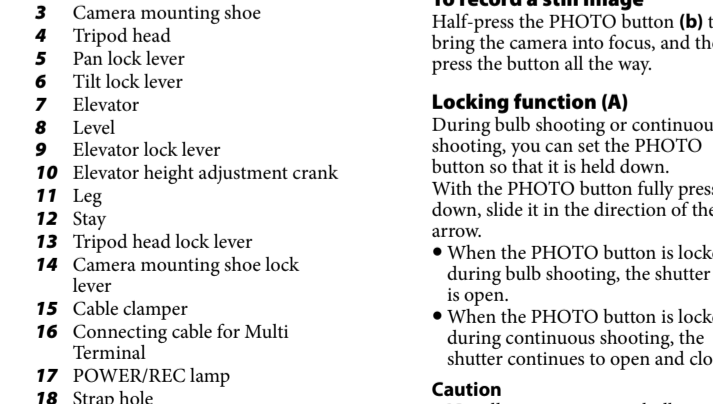
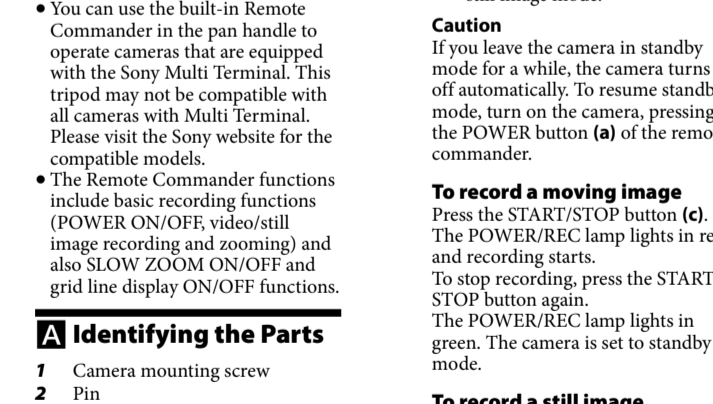
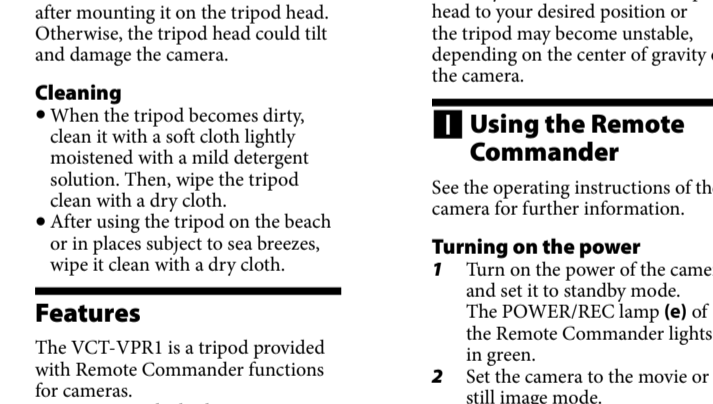
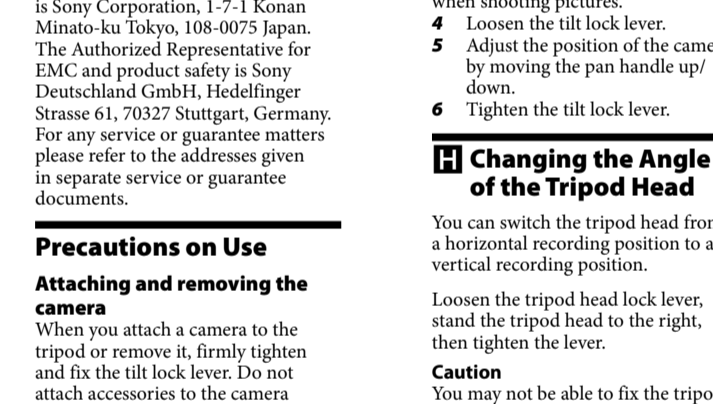
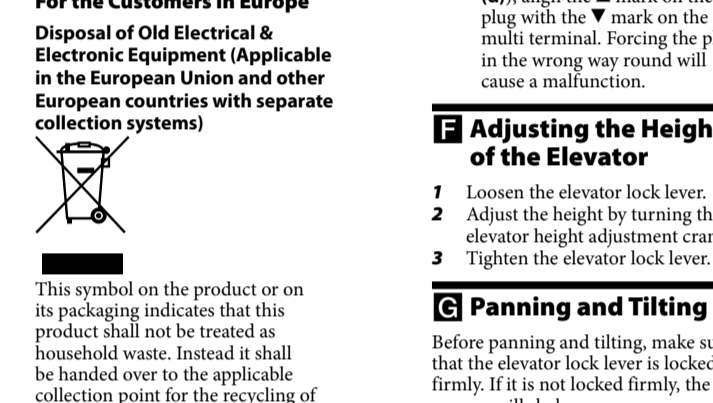
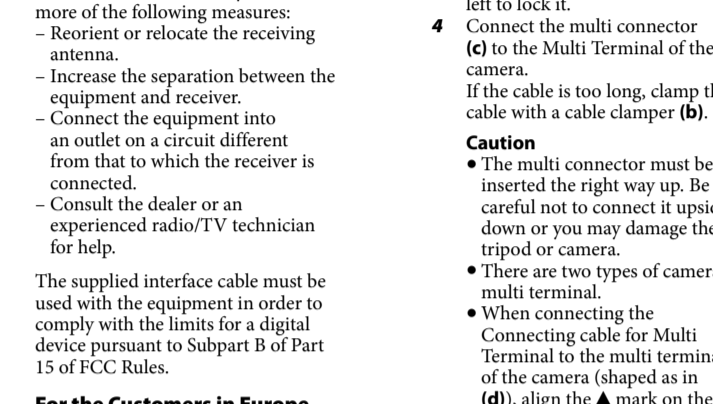
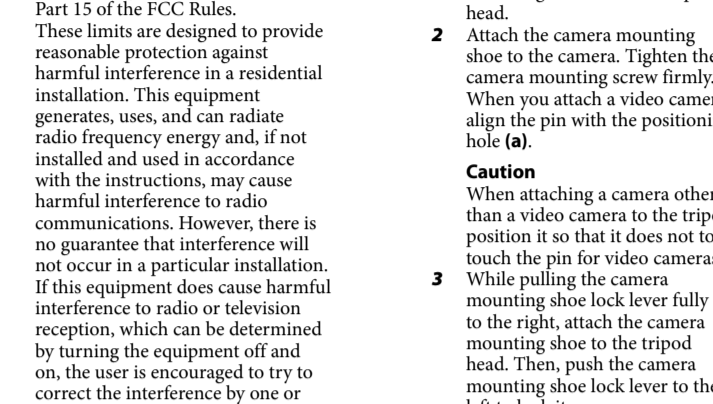
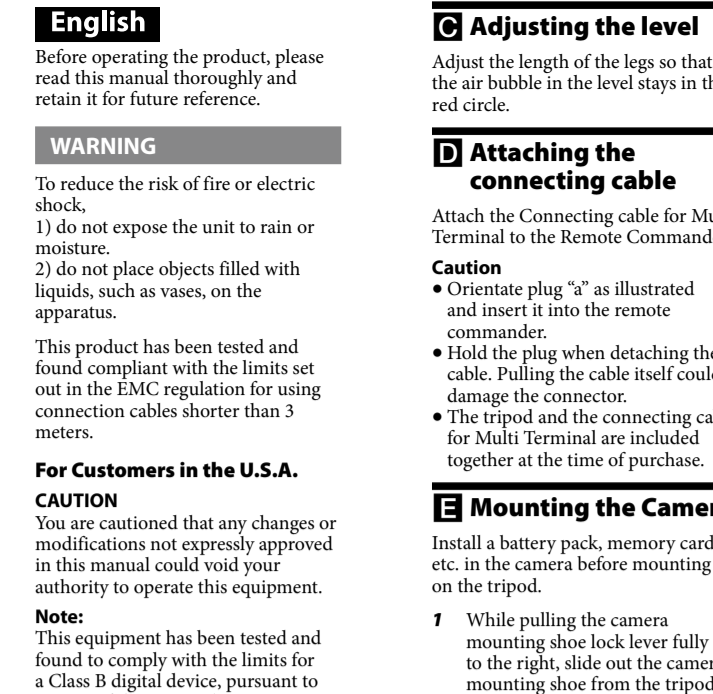
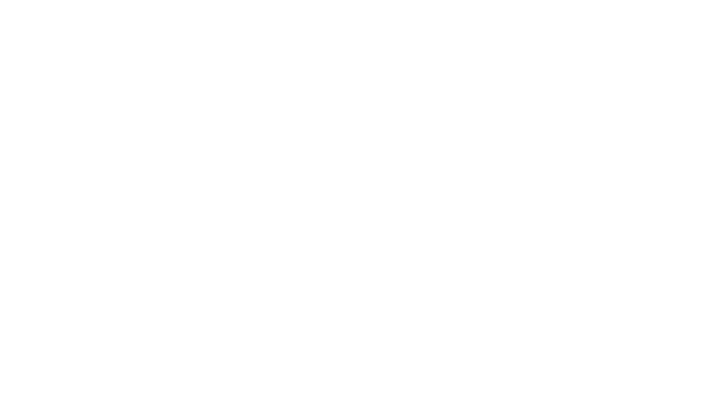
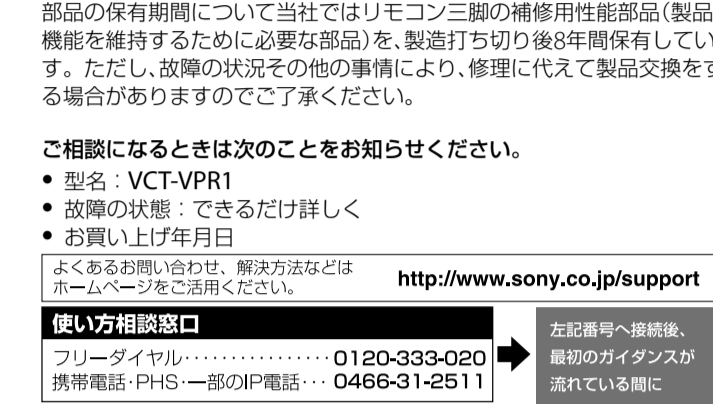
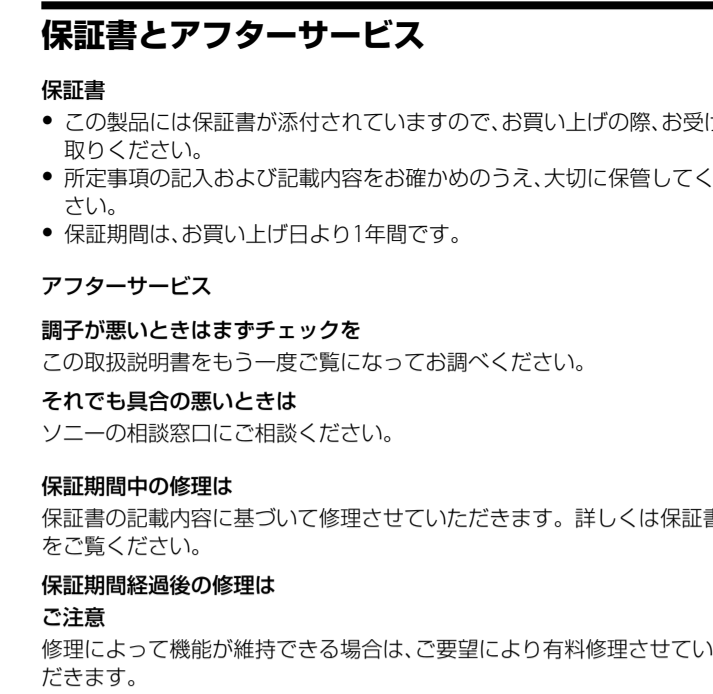
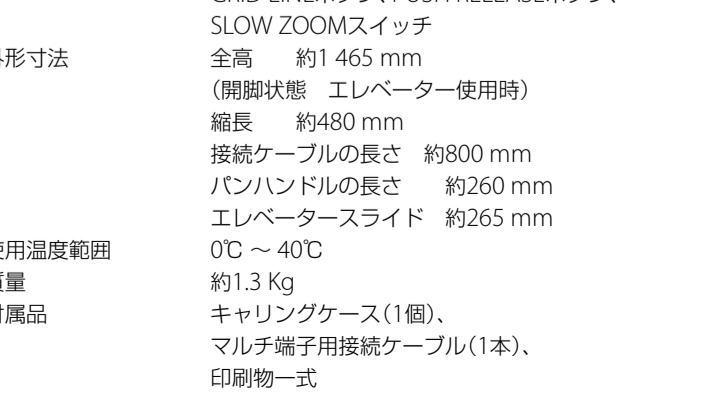
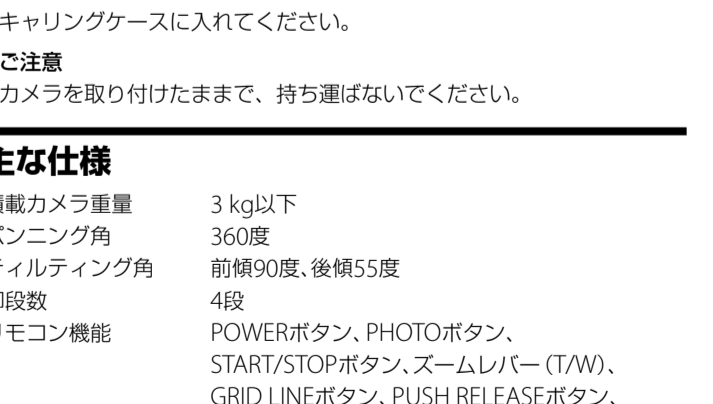
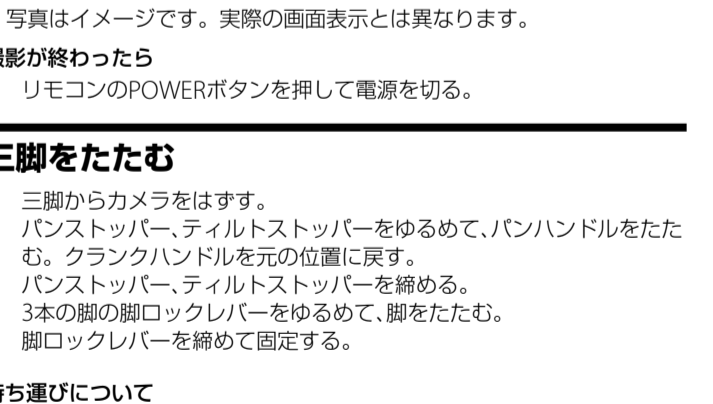
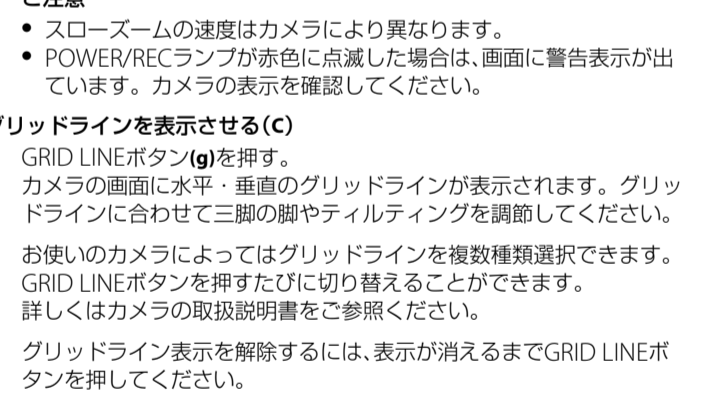
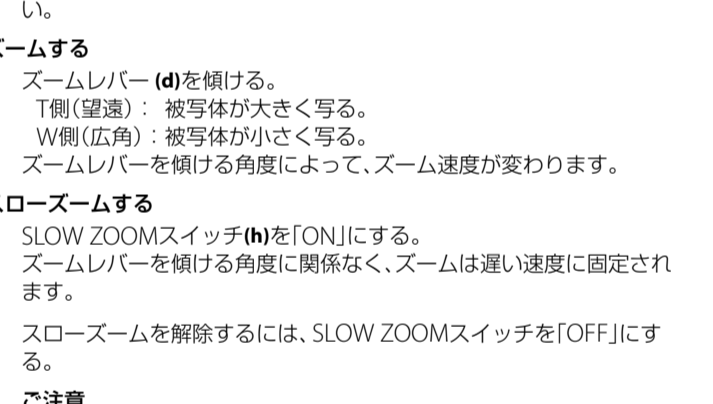
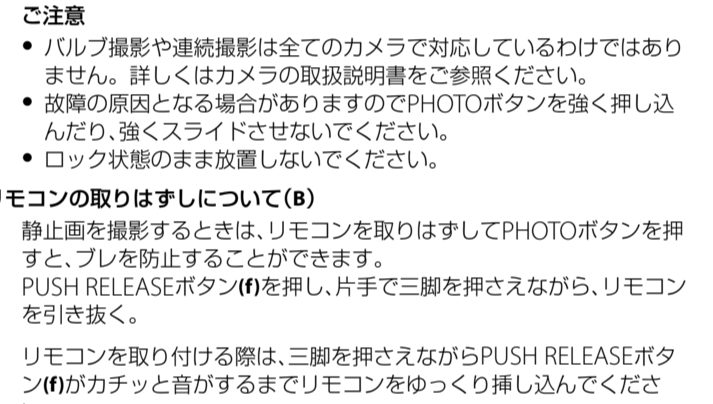
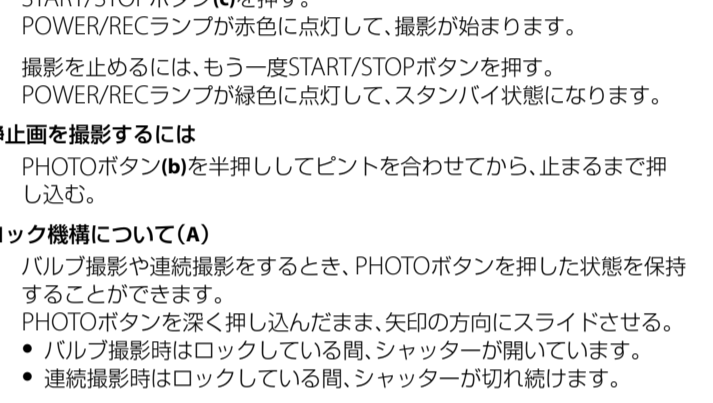
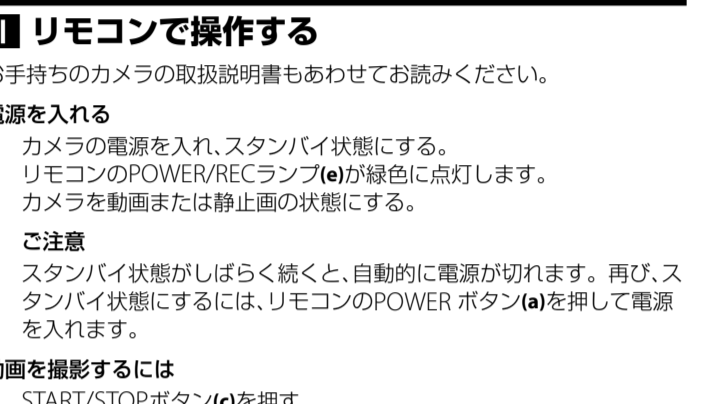
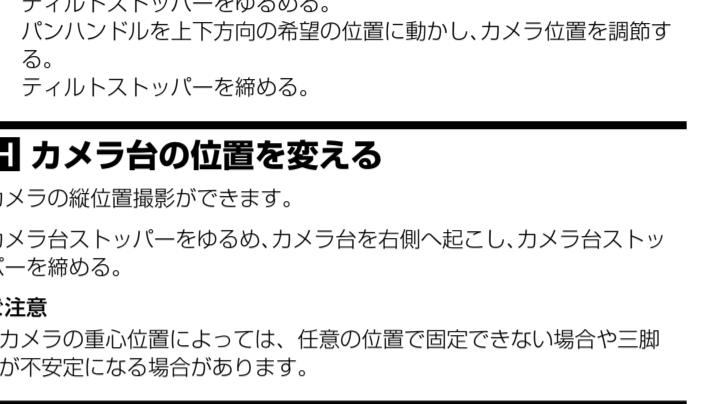
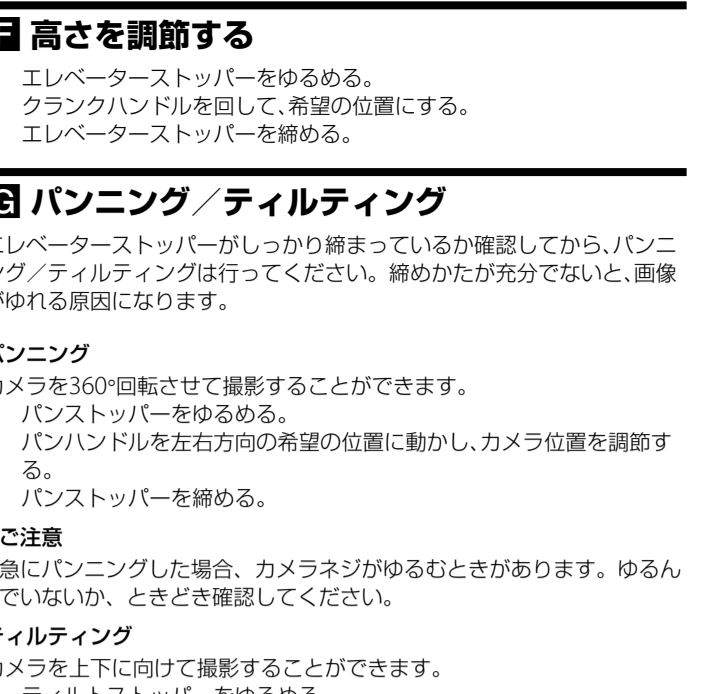
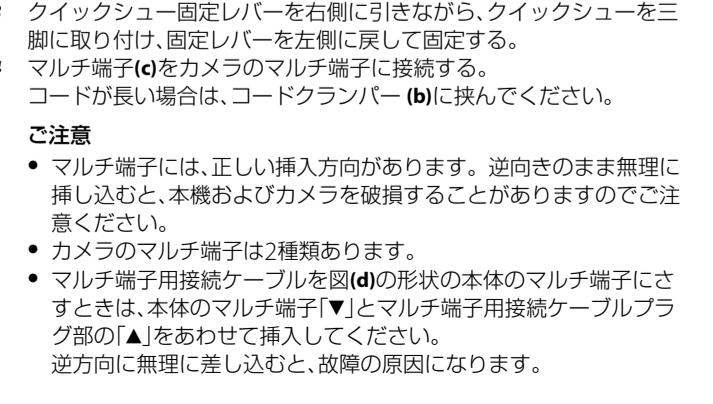
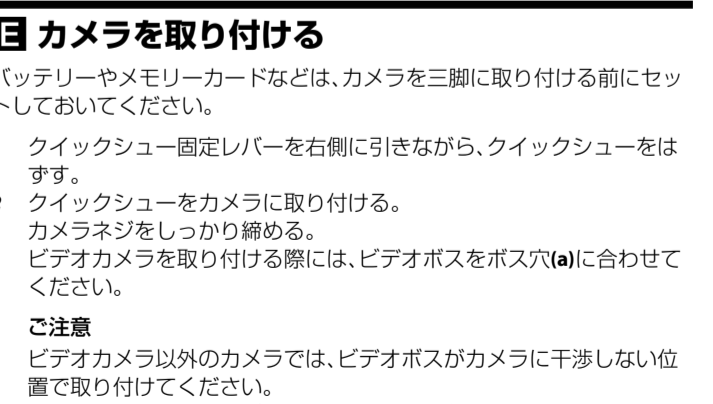
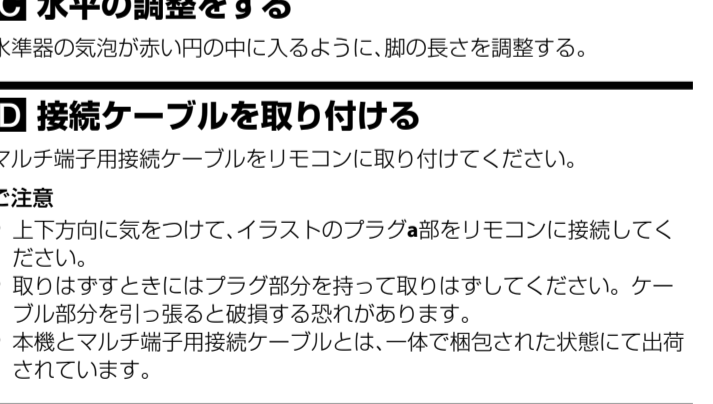
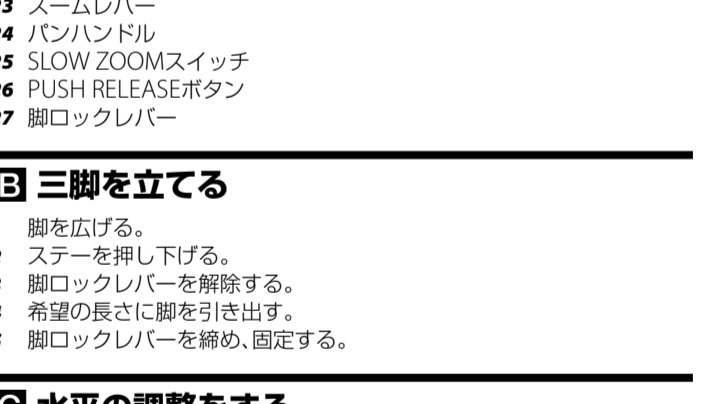
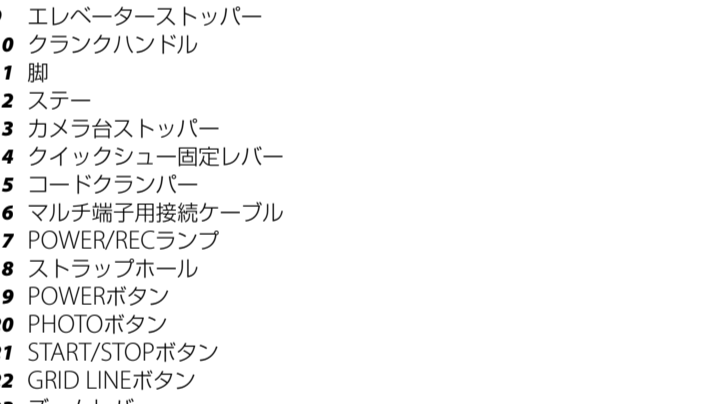
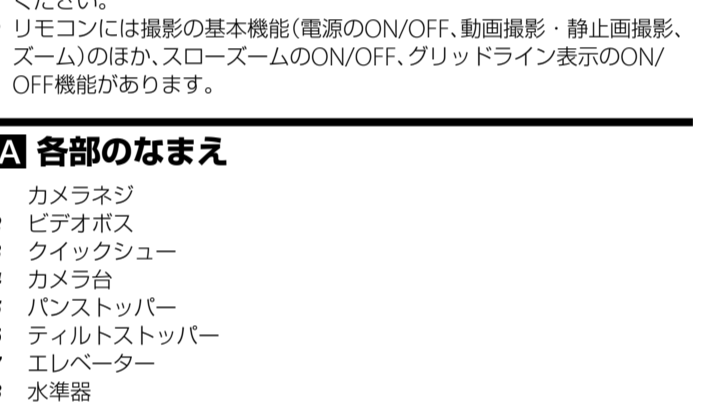
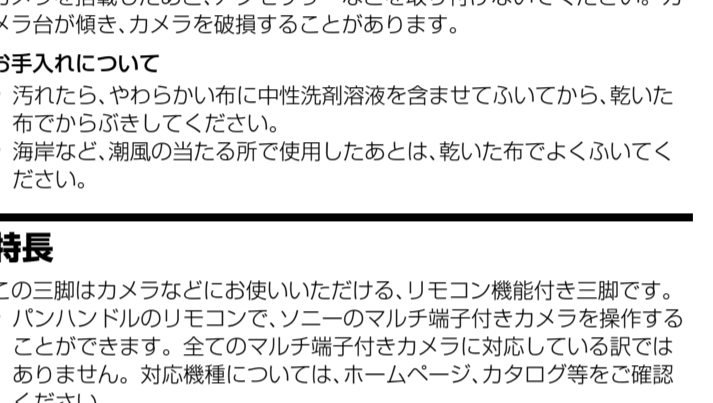
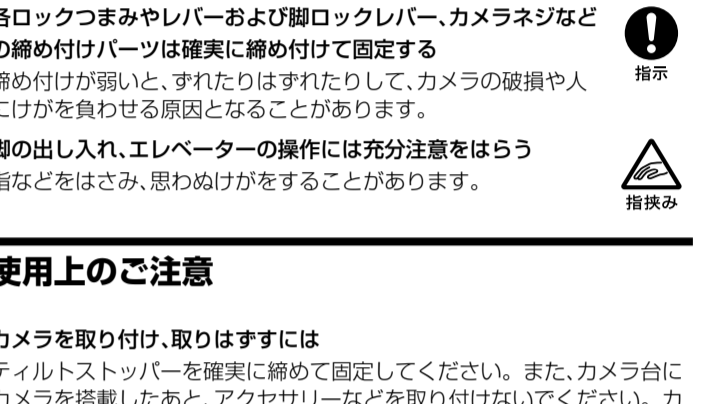
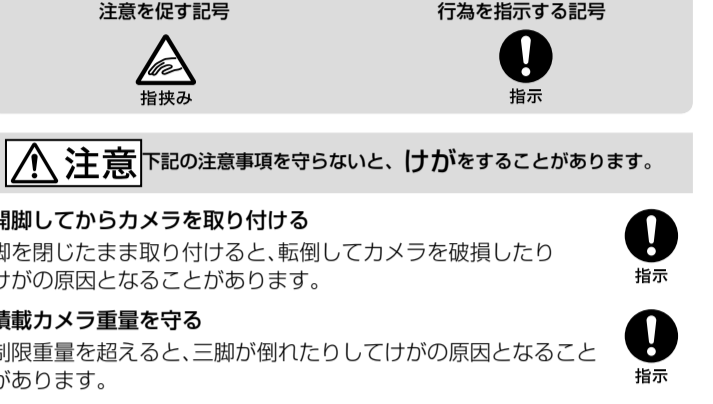
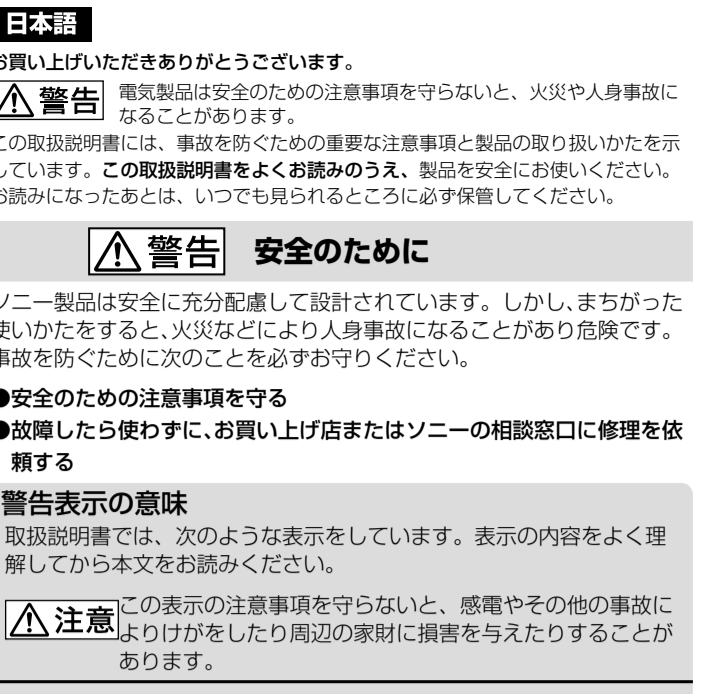
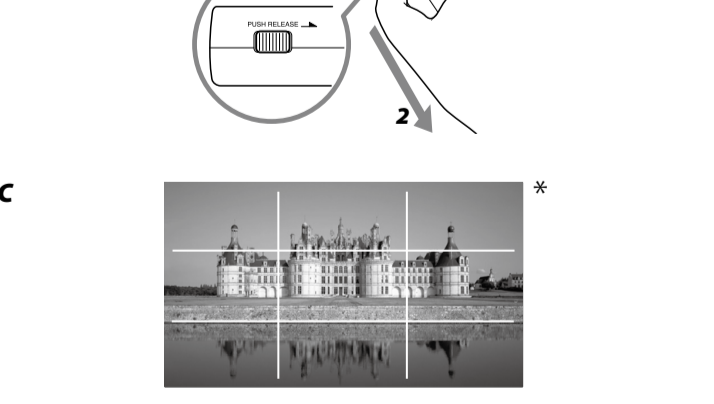
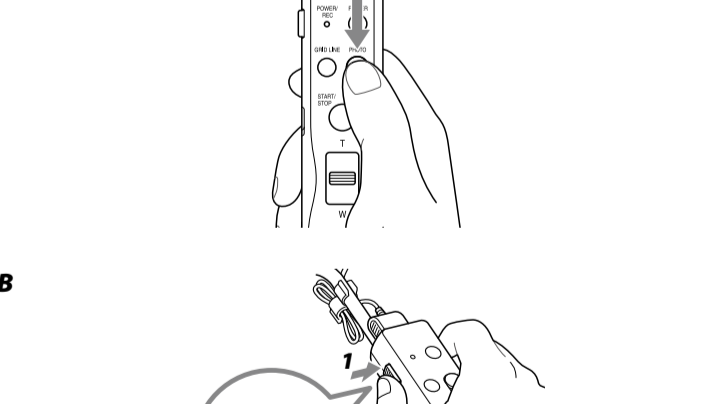
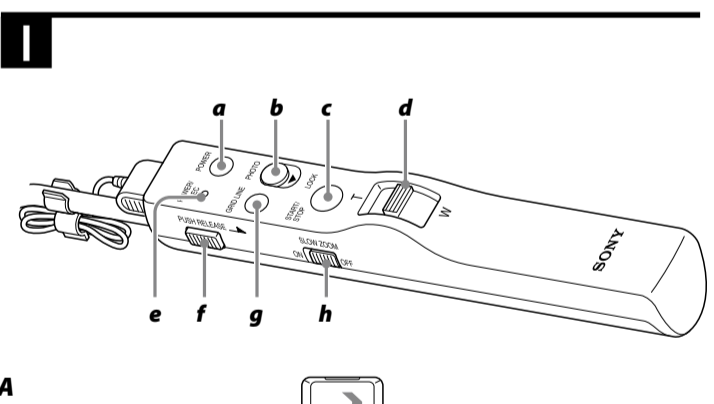
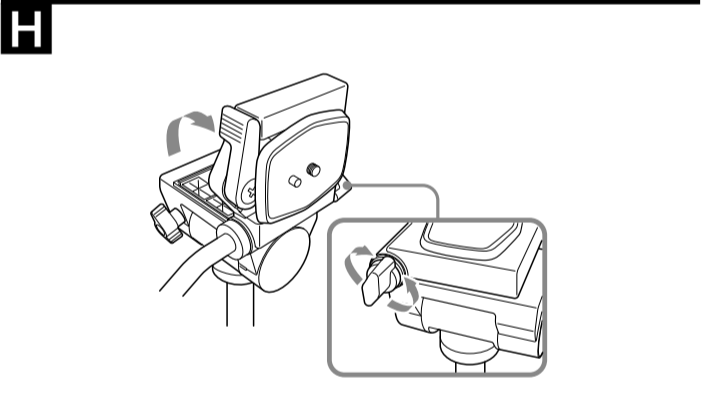
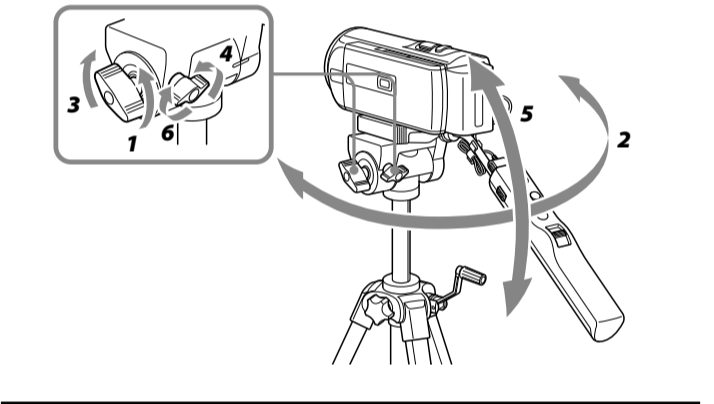
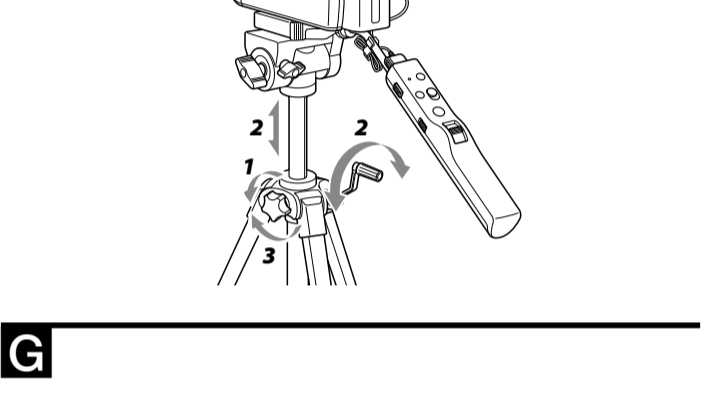
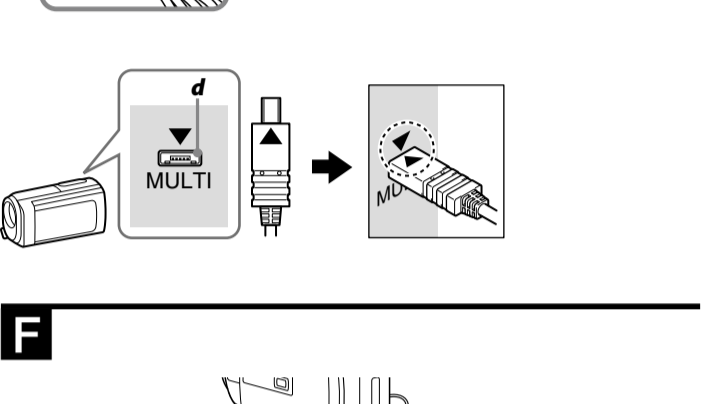
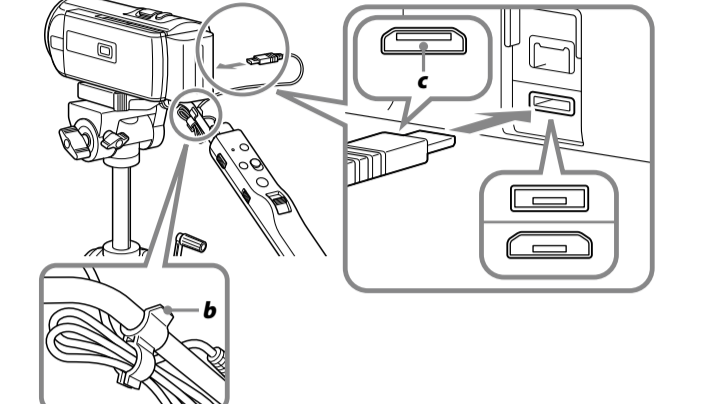
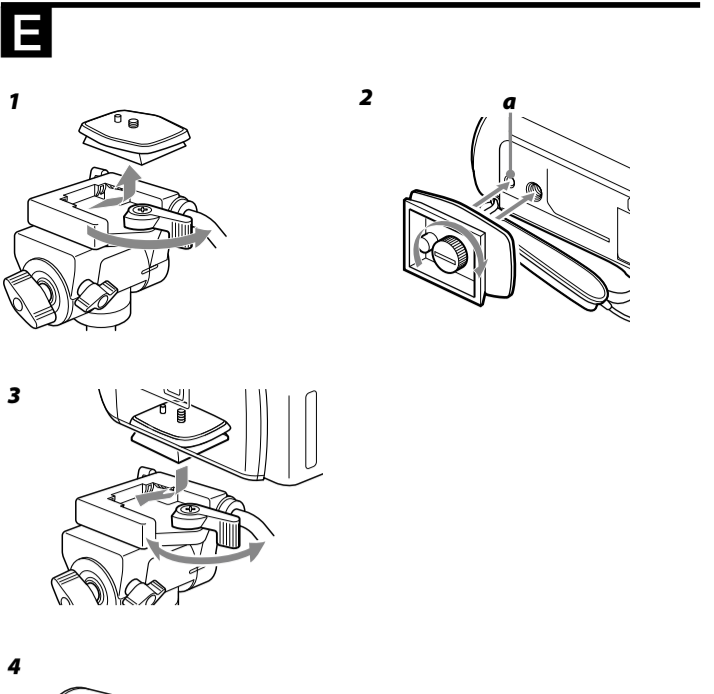
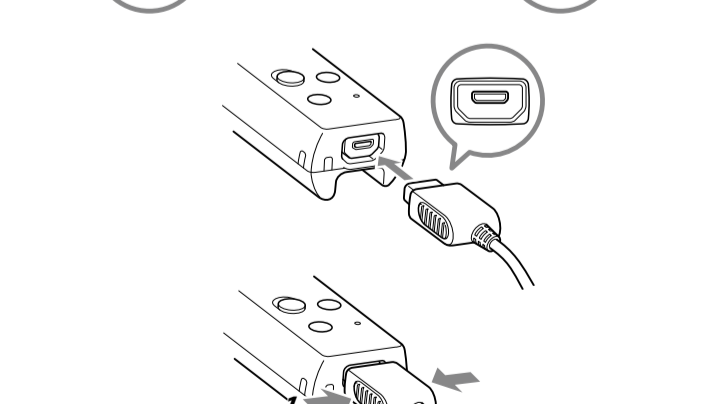
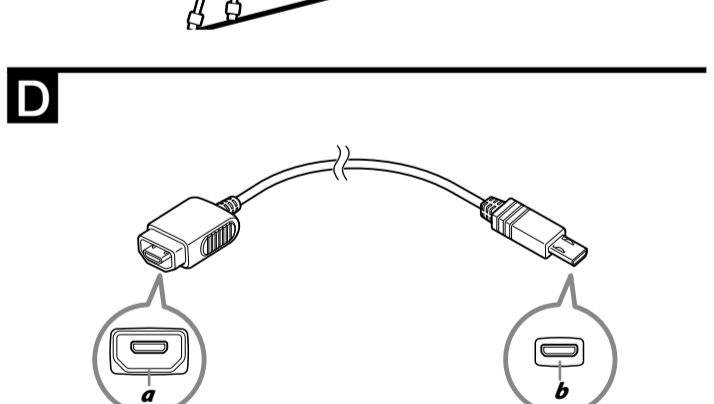
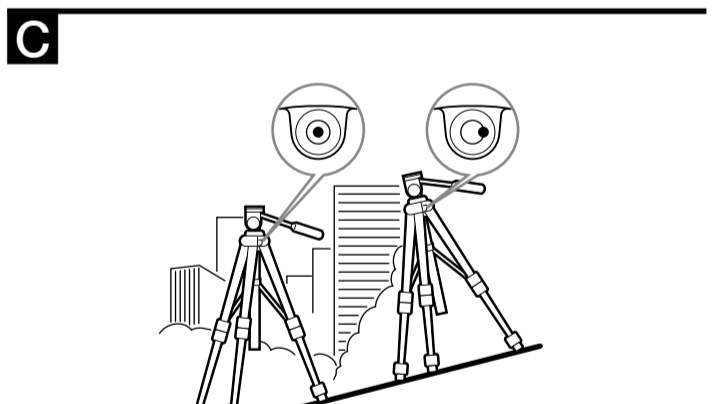
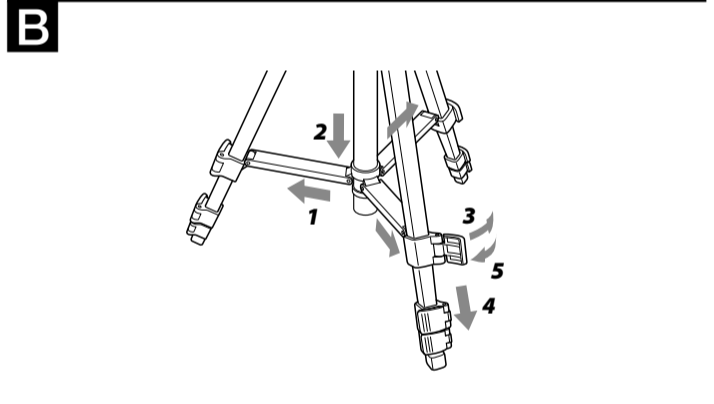
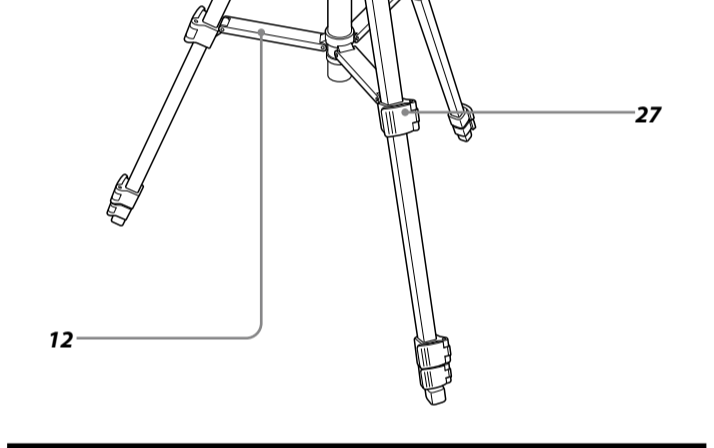
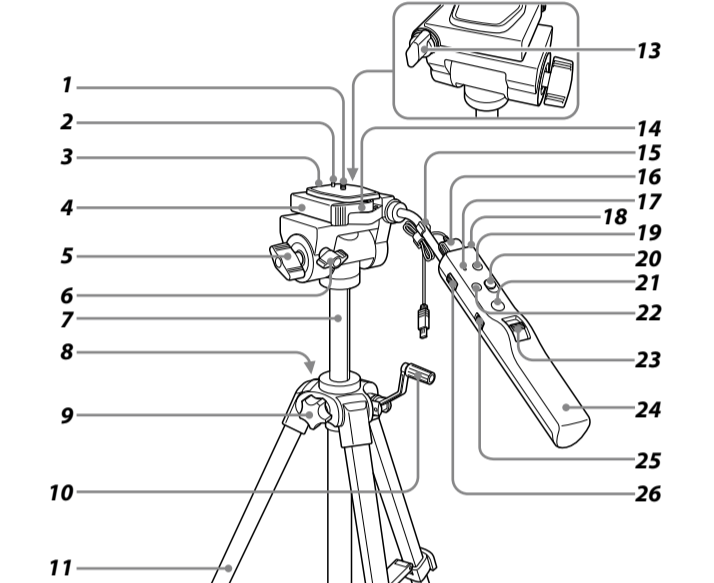

Quel que soit l'angle d'inclinaison du levier de zoom, le zooming est assuré par le levier de zooming. Pour annuler le zooming lent, réglez le commutateur SLOW ZOOM sur OFF.

Attention
Lorsque vous rattachez une caméra autre qu'un caméscope au levier de zooming, le levier de zooming est réglé en position « stop ». Ne touchez pas la goupille destinée aux caméscopes.

Attention
• Tout en tirant le levier de blocage du sabot de montage de caméra complètement vers la droite, rattachés le sabot de montage de caméra à la tête de trépied. Ensuite, repoussez le levier de blocage du sabot de montage de caméra vers la gauche et verrouillez-le.

Attention
• Raccordez le multiconnecteur (c) au sabot de montage de caméra. Si le câble est trop long, fixez-le avec le serre-câble (b).

Attention
• Le multiconnecteur doit être inséré dans le bon sens. Vérifiez à ne pas le brancher à l'envers sinon vous risquez d'endommager le levier de la caméra.
• Il existe deux types de connecteurs pour les appareils photo numériques.
• Lorsque vous raccordez le multiconnecteur à un mode déplié de votre caméra, vérifiez le défaut. Pour annuler l'affichage de la grille, appuyez sur la touche GRID LINE jusqu'à ce que la grille soit masquée.

* La photographie n'est qu'un exemple de cadrage. L'écran réellement affiché peut être différent.

Après l'enregistrement
Appuyez sur la touche POWER de la télécommande pour mettre la caméra hors tension.

Pliage du trépied

- Détachez la caméra du trépied.
- Déserrer le levier de blocage du pan et le levier de blocage de l'inclinaison et rabaisser la poignée de pan vers le bas. Remettre la manette de réglage de la hauteur de levier de zoom dans sa position habituelle.
- Serrer le levier de blocage du pan et le levier de blocage de l'inclinaison et rabaisser la poignée de pan vers le bas. Remettre la manette de réglage de la hauteur de levier de zoom dans sa position habituelle.
- Déserrer les leviers de blocage de réglage de longueur des pieds pour maintenir les pieds en place.
- Serrer les leviers de blocage du pied et le levier de blocage de l'inclinaison.
- Serrer les leviers de blocage du pied et le levier de blocage de l'inclinaison.

Transport du trépied
Veillez à transporter le trépied dans son étui de transport.

Attention
Ne transporter jamais le trépied avec la caméra dessus.

Spécifications

Charge maximale
3 kg (6 lb 10 oz.)

Angle de pan
160 degrés

Angle d'inclinaison
90 degrés vers le bas, 55 degrés vers le haut

Extension des pieds
Chaque pied : 4 tubes télescopiques.

Fonctions de la télécommande
Touche POWER, touche PHOTO, touche START/STOP, touche ZOOM, touche PUSH RELEASE, commutateur SLOW ZOOM.

Dimensions
Tailleur maximale : Environ 1 465 mm (57 3/4 pouces) (Pieds écartés et levateur complètement allongé)
Hauteur minimale : Environ 480 mm (19 pouces)
Longueur du câble de télécommande : Environ 800 mm (31 1/2 pouces)
Longueur de la poignée de pan : Environ 260 mm (10 1/4 pouces)
Course de levateur : Environ 265 mm (10 1/2 pouces)

Pliage de température de fonctionnement
0 °C à 40 °C (32 °F à 104 °F)

Poids
Environ 1,3 kg (2 lb 14 oz.)

Accessoires fournis
Etui de transport (1)
Câble de raccordement pour multiples (1)
Jeu de documents imprimés
La conception et les spécifications peuvent être modifiées sans préavis.

